

# SECURITY PRODUCTS™

A Miller Family Company

# 2026 CATALOG



*Better Locks for Better Living!*

**Safe Lock Solutions**  
Made in Kentucky, USA with Global Parts





[QSecurityIndustries.com](http://QSecurityIndustries.com)  
[QSecurityProducts.com](http://QSecurityProducts.com)  
[QSecurityEducation.com](http://QSecurityEducation.com)  
[QTactical.com](http://QTactical.com)

**With over 70 years of industry experience, QSecurity Products brings a legacy of expertise.  
We encompass manufacturing, distribution, research and development, and training.**

### **About QSecurity Products...**

QSecurity is the new name for a decades-old security technologies and education company headquartered in Nicholasville, Kentucky and owned by Clay Miller and April Truitt. We are a manufacturer of high security electronic safe locks for safes, vaults, ATM's, cash recyclers and money-handling equipment. Our innovation, design and product engineering are unmatched. Because our locks have fewer parts, they also have fewer problems. We offer lock bodies that provide a high level of security as well as keypads in innovative designs and finishes. QSecurity Products assembly, production, quality control, order fulfillment and administration is based in Nicholasville, Kentucky, USA. It is also the headquarters for QSecurity Industries, the parent company and QSecurity Education and QTactical.

QSecurity Industries purchased NL Lock in 2023. A company formed 20+ years ago by the late Nick Gartner, famed inventor & founder of the LaGard lock company. After selling his interest in LaGard, Nick founded NL in the Netherlands. In early 2023, Nick and Clay, both industry veterans and friends, entered into discussions regarding the future of NL Lock manufacturing. In late August of 2023, Nick transferred all NL Lock company assets to QSecurity Industries. Today, Clay and the staff of seasoned professionals are honored to carry on the legacy of incredible innovations by Nick Gartner, while moving ever forward with the next generation of high security technology.





































QSecurity Products is proud to have LockNet, Sargent & Greenleaf, Lockmasters® and MBAUSA as local neighbors.

859•241•2063  
Nicholasville, Kentucky, USA 40356

# Works With Matrix



## LOCKS

			KEYPADS	Premier <b>PI20-Dx</b>	Premier II <b>PI80-Nx</b>	ThinPut <b>TH20-D6</b>	EasyTouch <b>ET20-Dx</b>	QuickTouch <b>QT20-N3</b>	Premier Vision <b>TE20-xx</b>
Page 4	 	<b>UR40-xx</b> Universal RotoBolt							
Page 5	 	<b>EM20-xx</b> Large RotoBolt							
Page 6	 	<b>EM35-xx</b> Straight Bolt							
Page 7	 	<b>EM30-xx</b> MotorDrive Lock							
			Page 9	Page 10	Page 11	Page 12	Page 13	Page 14-15	

ON BOARD SOFTWARE FEATURES Page 8

ACCESSORIES Page 16

**QKits** Page 17

Our products are available through  
Lockmasters®, MBAUSA and  
other distributors.



# Universal RotoBolt

## UR40•XX



UL Type 1  
VdS EN1300 Class B



This innovative design offers 8-way flexibility in installation. The Universal may be mounted either RH, LH, VU or VD or it may be flipped over to block a reversed boltwork design. The lock body does not mount directly behind the spindle hole, offering a higher level of security. Ships standard with our Basic board (UR40•20), but may be ordered with a DIA (UR40•50), DIA Pro (UR40•55) or Digital board (UR40•60).

### Works With:

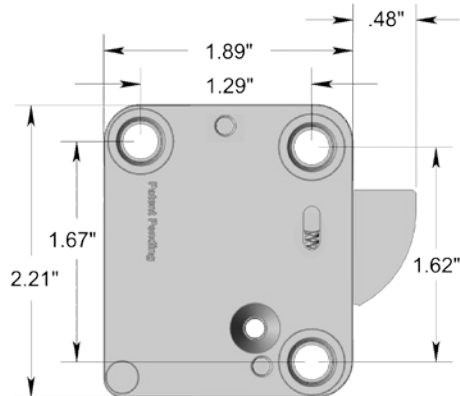

Fewer Parts = Fewer Problems!

# Large RotoBolt

## EM20•xx



UL Type 1  
VdS EN1300 Class B



Like the Universal, this innovative design offers 8-way flexibility in installation, but fits the industry standard “Magic Module.” The EM20 may be mounted either RH, LH, VU or VD or it may be flipped over to block a reversed boltwork design. Ships standard with our Basic board (EM20•20), but may be ordered with a DIA (EM20•50), DIA Pro (EM20•55) or Digital board (EM20•60).



### Works With:

PI20•Dx  
Premier



PI80•Nx  
Premier II



TH20•D6  
THinPut



ET20•Dx  
EasyTouch



QT20•N3  
QuickTouch



TE20•xx  
Premier Vision

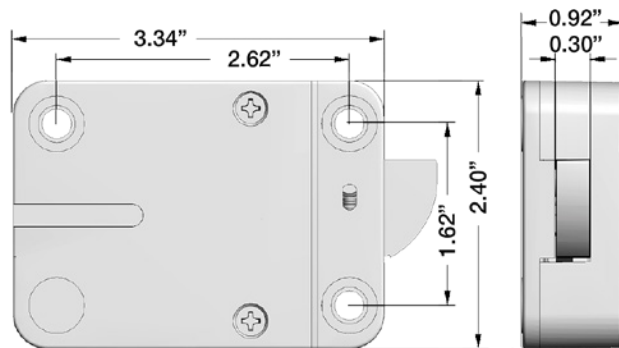

# Straight Bolt

## EM35•xx

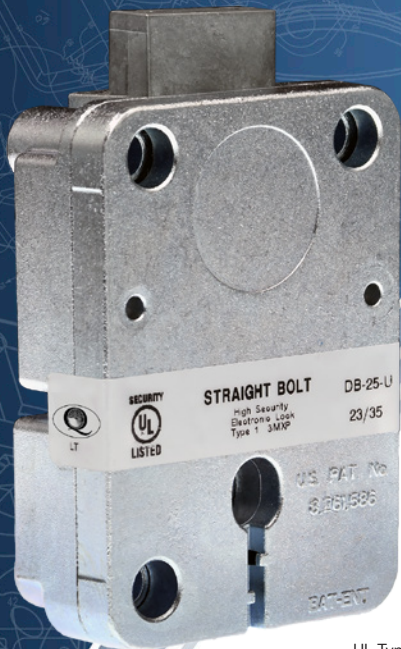

Comparable to traditional deadbolt-style safe locks, the EM35 fits the industry standard “Magic Module,” employing a spindle to transmit motion from rotating keypad to lock body, thereby retracting the lock bolt. The exception is - when coupled with an EasyTouch keypad - the keypad is stationary, with the central knob retracting the lock bolt. The end of the lock bolt is drilled to accept lock bolt extensions. Included spindle accommodates a 5” door thickness. Longer spindles are available. Ships standard with our Basic board (EM35•20), but may be ordered with a DIA (EM35•50), DIA Pro (EM35•55) or Digital board (EM35•60).

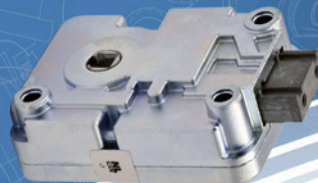

### Works With:

PI20•Dx  
Premier



TE20•xx  
Premier Vision



TH20•D6  
THinPut



ET20•Dx  
EasyTouch



UL Type 1

VdS EN1300 Class B

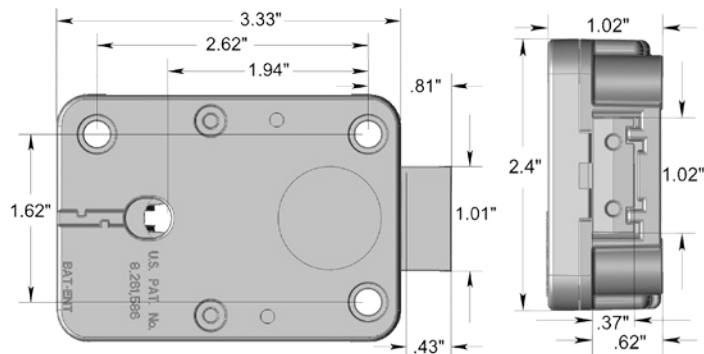

# MotorDrive Lock

**EM30•xx**



The EM30 fits the industry standard “Magic Module” and may be mounted either RH, LH, VU or VD. The end of the lock bolt is drilled to accept lock bolt extensions, providing additional customization options. May be ordered with either a DIA (EM30•50), DIA Pro (EM30•55) or Digital Board (EM30•60).



**Works With:**

**PI20•Dx**  
Premier



**PI80•Nx**  
Premier II



**TH20•D6**  
ThinPut



**ET20•Dx**  
EasyTouch



**QT20•N3**  
QuickTouch



**TE20•xx**  
Premier Vision

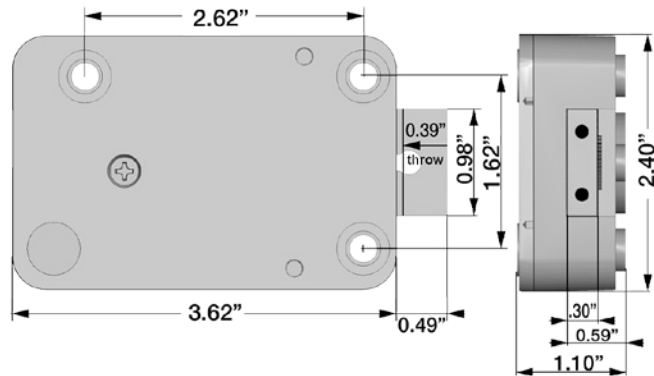

VdS EN1300  
Class B





# Analog / Digital On Board Software Features

	BASIC	DIA	DIA Pro	DIGI	DIGIPRO	LOCK+
<b>Digital Keypad</b>	---	---	---	<b>TE20-xx(30B)</b>	<b>TE20-xx(30A)</b>	<b>TE20-xx(30D)</b>
<b>Lock Part # Suffix</b>	<b>•20</b>	<b>•50</b>	<b>•55</b>	<b>•60</b>	<b>•60</b>	<b>•60</b>
Users	1	9 (8)	Up to 39 (30)	up to 34 (30)	up to 34 (30)	up to 34 (30)
TD Override Users	---	0 (1)	0 (9)	0 (4)	0 (4)	0 (4)
Master	---	---	1 (optional)	1 (8-digit)	1 (8-digit)	1 (8-digit)
Service	---	---	---	1 (optional)	1 (optional)	1 (optional)
Manager	1	1	1	1	1	1
Time Delay (TD)	0-99 min	0-99 min	0-99 min	0-99 min	0-99 min	0-99 min
Open Window	1-19 min	1-19 min	1-19 min	1-19 min	1-19 min	1-19 min
Dual Control Mode	---	●	●	●	●	●
Daylight Saving Time (DST)	---	---	---	---	●	●
Time Lock	---	---	---	---	●	●
Weekly Program	---	---	---	---	1	1
Immediate Time Lock	---	---	---	---	●	●
Silent Alarm	---	● w/Alarm Box	● w/Alarm Box	● w/Alarm Box	● w/Alarm Box	● w/Alarm Box
Remote Disable Input	---	● w/Alarm Box	● w/Alarm Box	● w/Alarm Box	● w/Alarm Box	● w/Alarm Box
Audit Trail (# of Events)	---	---	---	---	2000	2000
OLED Screen	---	---	---	●	●	●
Bluetooth LE Module	---	---	---	---	---	●
OneTime Code (OTC)	---	---	---	---	---	●
Wrong Try Attempts	4	4	4	4	4	4
Penalty Lockout Time	5 min	5 min	5 min	5 min	5 min	5 min
NETIC Cloud Compatible	---	---	---	---	---	●
Mobile App Support	---	---	---	---	---	●
Code Length	6 Digits	6-8 Digits	8 Digits	6-8 Digits	6-8 Digits	6-8 Digits
Dual Control OTC Option	---	---	---	---	---	●
Hotel Mode		MotorDrive Only				
Mute Keypad Mode		●				

Rev. 0326

# Premier Keypad

PI20•Dx



The new and improved Premier PI20-Dx can now be mounted either as a rotating or stationary keypad – no additional parts needed. Featuring integrated LED lights for low-light conditions, this versatile design is available in a variety of finishes, and now also in METAL! Mounts on horizontally-oriented mounting holes. See MA-2 (*Accessories page 16*) for vertical screw patterns. 9V battery access is via a sliding door at the keypad base. Stocked in ABS Black Velvet, Bright Chrome, Textured Black or Satin Chrome metal. Black Pearl and other custom finish quotes available on request.

**Works With:** EM20 Large RotoBolt Lock, EM30 MotorDrive Lock, EM35 Straight Bolt

**UR40**  
Universal RotoBolt



— Fewer Parts = Fewer Problems! —



# Premier II Keypad

## PI80•Nx



The Premier II is the latest in the Premier Keypad series. This keypad can be mounted to either vertical or horizontal mounting holes – no additional parts required. The Premier II features integrated LED lights for effective use in low-light conditions. Battery access is via a convenient pull-down drawer, eliminating the need for cable attachment at battery terminals. Stocked in ABS Black Velvet or Bright Chrome and now in Satin Chrome metal. Non-rotating, not for use with EM35-xx.



**Works With:** EM20 Large RotoBolt  
EM30 MotorDrive Lock  
UR40 Universal RotoBolt



*Fewer Parts = Fewer Problems!*

# THinPut Keypad

## TH20•D6



This discreet and low-profile design is an ideal solution for wall safes and inner compartment doors. Features integrated LED lights for effective use in low-light conditions.

THinPut requires either our 9V Battery Box (N7010) or one of our optional power regulator boxes (see *Accessories page 16*) for wiring to external power sources. To ensure uninterrupted functionality during low battery situations or power outages, a 9V battery may be temporarily connected to the strategically placed 9V contacts at the keypad base. Requires no additional parts to convert from fixed keypad to rotating for use with our EM35 Straight Bolt lock. Mounts on horizontal mounting holes, or optional MA2 (see *Accessories page 16*) may be used for vertical mounting holes.

Stocked in Black Textured finish.

### Battery Box N7010

External Power Source or  
Battery Box Required



**Works With:** EM20 Large RotoBolt, EM30 MotorDrive Lock, EM35 Straight Bolt

UR40 Universal RotoBolt



# EasyTouch Keypad

## ET20•Dx



**Great for  
Corporate  
Customization**



The EasyTouch Keypad is a versatile option, offering the flexibility of use with or without a rotating knob (included). When used without the knob, the front face of the keypad provides an excellent space for customization. The angled keypad enhances convenience both for viewing numbers and for secure code input. Mounts to either horizontal or vertical screw patterns – no additional parts needed. Stocked with Black or Chrome housing. Ships with both knob and flat plate.



**Works With:** **EM20** Large RotoBolt  
**EM30** MotorDrive Lock  
**EM35** Straight Bolt  
**UR40** Universal RotoBolt



# QuickTouch Keypad

QT20•N3



The QuickTouch Keypad presents a user-friendly design with top reading and effortless code input. Ideal for under-counter equipment or corporate decor, it is available in Black Velvet and features integrated LEDs for effective use in low-light conditions. The front face offers ample space for customization, and the non-rotating keypad provides easy access to the 9V battery through a convenient sliding drawer. Mounts only to horizontally-oriented screw holes. Not for use with our EM35 StraightBolt lock.



**Now Available  
with Backlit Keypad**

**Works With:** EM20 Large RotoBolt Lock    EM30 MotorDrive Lock

UR40 Universal RotoBolt



*Fewer Parts = Fewer Problems!*



# Premier Vision

## TE20•Xx 30A/B/D



The Premier Vision is for use with our line of digital locks. Three levels of features are offered: Lock+(D), DigiPro (A) and DigiBasic (B). See the chart (Page 8) for details. If you have questions about which version is right for your application, consult a member of our sales team. 9V battery access is via a sliding door at the keypad base. Stocked in ABS Black Velvet or Bright Chrome, and now in Satin Chrome metal. Black Pearl and other custom finish quotes available on request.



**Works With:** EM20 Large RotoBolt Lock  
EM30 MotorDrive Lock  
EM35 Straight Bolt  
UR40 Universal RotoBolt



*Fewer Parts = Fewer Problems!*



Wireless Access Control & One Time Codes

Ideal for ATMs, dispensaries and cash intensive retail operations.

### Key Features:

- One-Time-Code (OTC) Generation and Distribution from a central web-based portal
- Cell phone, tablet, desktop computer or laptop compatible
- Link to LockPlus via Bluetooth
- Verify Open and Closed Seals
- Prevents secondary safe opening until Closed Seal received
- Disable and authorize users via portal
- Maintains in-depth audit with time, date and user information
- Online and offline operation
- Unlimited # of users
- Scheduled, time-limited and date-based access control
- No external power or data wiring needed
- Two Year Warranty
- Components sourced from allied countries
- Assembled and rigorously tested in Kentucky, USA
- Android and iOS applications
- Mac & PC compatible



**Works With:** EM20 Large RotoBolt Lock  
EM30 MotorDrive Lock  
EM35 Straight Bolt

UR40  
Universal  
RotoBolt



# Accessories

## **N7060 Battery/Alarm Box for DIA Locks**



Enables remote disable and duress functions when tied to facility alarm panel

## **N7010 Auxiliary Battery Box**



Holds one 9v battery

## **N7050 Reset Box for DIA Locks**



Allows recovery of factory settings

## **AS10-65**

### **Digital Alarm Interface Box**

Enables remote disable and duress functions when tied to facility alarm panel



## **MA-2 Mounting Adapter Plate**



For use with Premier Keypads on safes with mounting holes at 12 o'clock & 6 o'clock.

## **N8040**

### **Battery Box for Universal Lock**



Enables ThinPut keypad use with Universal locks



## **N4003 Power Regulator Box**

Enables lock operation on 12-24VDC (except Universal UR20/40)

## **W024**

### **Rotating Adapter Kit**



Includes P170 & P171  
For use with our legacy Premier Keypads

*For other accessories, see our website or contact our sales team.*

# Our most popular lock/keypad combos bundled together in one handy box



- QKU20N1** Universal RotoBolt, Premier II Keypad **Chrome Basic**
- QKU20N3** Universal RotoBolt, Premier II Keypad **Black Velvet Basic**
- QKU20N9** Universal RotoBolt, Premier II Keypad **Satin Chrome Basic**
- QKU50N1** Universal RotoBolt, Premier II Keypad **Chrome DIA 9 user**
- QKU50N3** Universal RotoBolt, Premier II Keypad **Black Velvet DIA 9 user**
- QKU50N9** Universal RotoBolt, Premier II Keypad **Satin Chrome DIA 9 user**



- QKR20N1** Large RotoBolt, Premier II Keypad **Chrome Basic**
- QKR20N3** Large RotoBolt, Premier II Keypad **Black Velvet Basic**
- QKR20N9** Large RotoBolt, Premier II Keypad **Satin Chrome Basic**
- QKR50N1** Large RotoBolt, Premier II Keypad **Chrome DIA 9 user**
- QKR50N3** Large RotoBolt, Premier II Keypad **Black Velvet DIA 9 user**
- QKR50N9** Large RotoBolt, Premier II Keypad **Satin Chrome DIA 9 user**

- QKS20D1** Straight Bolt, Premier Keypad **Chrome Basic**
- QKS20D3** Straight Bolt, Premier Keypad **Black Velvet Basic**
- QKS20D9** Straight Bolt, Premier Keypad **Satin Chrome Basic**
- QKS50D1** Straight Bolt, Premier Keypad **Chrome DIA 9 user**
- QKS50D3** Straight Bolt, Premier Keypad **Black Velvet DIA 9 user**
- QKS50D9** Straight Bolt, Premier Keypad **Satin Chrome DIA 9 user**



## **Combi+ Manipulator Q8030**

This highly capable machine can open most mechanical safe locks. Average opening time is 60-90 minutes.

The Combi + is easily set up, controlled via tablet and user friendly, walking the operator through each step of the process.

It can open many different styles of 3 and 4 wheel safe locks including UL-Listed Group II and other non-UL Listed mechanical safe locks.



## **Combi QX3 Autodialer Q8035**

Combi QX3 is a high speed, wirelessly-controlled combination lock dialer for opening Group 2 three and four wheel mechanical locks.

Combi QX3 uses a precision stepper motor with an optical encoder to maintain accuracy even at exceptionally high speeds.

This, combined with carefully designed dialing algorithms, allows Combi Qx3 to open most standard three-wheel combination locks in 8 hours or less.





QSecurity Education is built on a foundation of Tradition and Excellence. Since 1955, the Miller family has been committed to delivering outstanding customer service and technical support, earning a reputation as leaders in the security field. We proudly continue this legacy today. We take pride in our leadership in safe and lock training. Our instructors are highly experienced technicians with decades of hands-on knowledge, eager to share their expertise in our immersive training. Our training approach blends tabletop skill development with practical exercises to ensure a well-rounded learning experience. Additionally, our administrative team is well-versed in managing government contracts and ensuring compliance with state and federal regulations.

***Courses:***

- GSA Inspector & Technician Certification
- Kaba Mas CDX-10 Certification
- Kaba Mas X-10 Certification
- Government Safe Locks
- Locksmithing I: Locks & Keys
- Locksmithing II: Doors & Hardware
- Fed-Std-809E: Drilling & Repair
- or let us design a course for your group*



**QSecurityEducation.com**



859•241•2063

sales@QsecurityProducts.com

Nicholasville, Kentucky, USA



**2026**  
**CATALOG**



## Manufacturing

At QSecurity Products, our goal is to make high quality, high security products that work! For a long...long....time. Every step of the way, from design to completion, leading industry veterans are hands-on. We've sourced the best possible materials and components from the USA and Allied countries, made to OUR specifications, and it's here in Kentucky where it all comes together. Though our product lineup is extensive, stay tuned - we have still greater advancements in the works!

*Innovative. Elegant. Simplified High Security.*

Because Fewer Parts = Fewer Problems!



QSecurityProducts.com